

# 车制型滚针轴承

无内圈

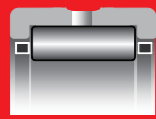

RNA49, RNA59, RNA69 (Fw ≤ 35), NK

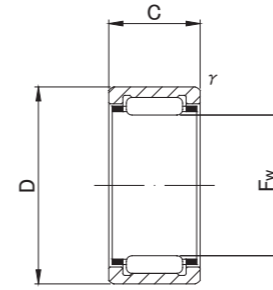

NK (Fw ≤ 10)

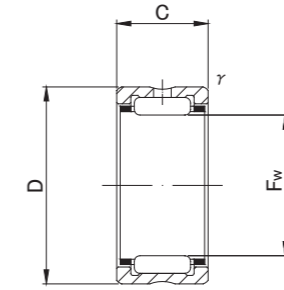

RNA49, RNA59, RNA69 (Fw ≤ 35), NK

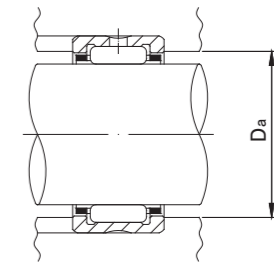

## RNA49, RNA59, RNA69, RNA48, NK 类型

轴直径 (mm)	类型代号					尺寸 (mm)				标准安装尺寸 (mm)	基本额定 动负荷	基本额定 静负荷	允许转速 *	质量	相关轴承型号								
	RNA 49	RNA 59	RNA 69	RNA 48	NK	Fw	D	C	r <sub>s</sub> 最小						Da 最大	Cr N	Cor N	rpm	g (大约)	内圈	带内圈		
5	—	—	—	—	NK5/10 NK5/12	5 +0.018	10	10	0.15	6.5	2 420	1 950	40 000	3.4	—	—							
	—	—	—	—		5 +0.010	10	12	0.15								6.5	3 080	2 660	40 000	4.2	—	—
6	—	—	—	—	NK6/10 NK6/12	6 +0.018	12	10	0.15	7.5	2 700	2 320	37 000	5.3	—	—							
	—	—	—	—		6 +0.010	12	12	0.15								7.5	3 440	3 170	37 000	6.4	—	—
7	RNA 495	—	—	—	— NK7/10 NK7/12	7 +0.022	13	10	0.15	8.5	2 960	2 690	34 000	5.9	IR5710	NA495							
	—	—	—	—		7 +0.013	14	10	0.3								8.5	3 600	2 960	34 000	6.9	—	—
	—	—	—	—		7	14	12	0.3								8.5	4 610	4 050	34 000	8.3	—	—
8	RNA 496	—	—	—	— NK8/12 NK8/16	8 +0.022	15	10	0.15	13.8	3 900	3 400	32 000	7.3	IR6810	NA496							
	—	—	—	—		8 +0.013	15	12	0.3								13	5 100	4 700	32 000	9	IR5812	NKI 5/12
	—	—	—	—		8	15	16	0.3								13	7 100	7 300	32 000	13	IR5816	NKI 5/16
9	—	—	—	—	NK9/12 NK9/16 —	9 +0.022	16	12	0.3	14	5 500	5 300	30 000	10	IR6912	NKI 6/12							
	—	—	—	—		9 +0.013	16	16	0.3								14	7 600	8 200	30 000	13.2	IR6916	NKI 6/16
	RNA 497	—	—	—		9	17	10	0.15								15.8	4 500	3 600	30 000	9.3	IR7910	NA497
10	—	—	—	—	NK10/12 NK10/16 —	10 +0.022	17	12	0.3	15	5 900	6 000	28 000	10.7	IR71012	NKI 7/12							
	—	—	—	—		10 +0.013	17	16	0.3								15	8 200	9 200	28 000	14.3	IR71016	NKI 7/16
	RNA 498	—	—	—		10	19	11	0.2								17.4	6 200	5 000	28 000	12.6	IR81011	NA498
12	—	—	—	—	NK12/12 NK12/16 —	12 +0.027	19	12	0.3	17	6 600	7 300	26 000	12.2	IR91212	NKI 9/12							
	—	—	—	—		12 +0.016	19	16	0.3								17	9 200	11 200	26 000	16.3	IR91216	NKI 9/16
	RNA 499	—	—	—		12	20	11	0.3								18	6 600	6 300	26 000	13.6	IR91211	NA499

\* 适合油润滑。如果是润滑脂润滑，降低到该数值的 60%。

# 车制型滚针轴承

无内圈

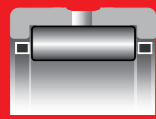

RNA49, RNA59, RNA69 (Fw ≤ 35), NK

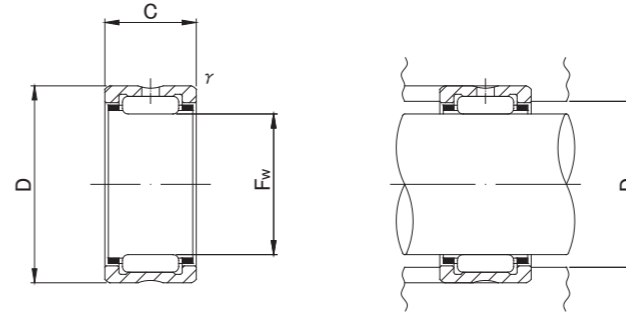

## RNA49, RNA59, RNA69, RNA48, NK 类型

轴直径 (mm)	类型代号					尺寸 (mm)				标准安装尺寸 (mm)	基本额定 动负荷	基本额定 静负荷	允许转速 *	质量	相关轴承型号		
	RNA 49	RNA 59	RNA 69	RNA 48	NK	Fw	D	C	r <sub>s</sub> 最小	Da 最大	Cr N	Cor N	rpm	g (大约)	内圈	带内圈	
14	RNA 4900	—	—	—	—	14	+0.027 +0.016	22	13	0.3	20	9 200	10 100	24 000	16.5	IR101413	NA4900
	—	—	—	—	NK14/16	14		22	16	0.3	20	11 800	13 700	24 000	21	IR101416	NKI 10/16
	—	—	—	—	NK14/20	14		22	20	0.3	20	14 800	18 500	24 000	26.5	IR101420	NKI 10/20
15	—	—	—	—	NK15/16	15	+0.027 +0.016	23	16	0.3	21	12 400	14 900	23 000	22.5	—	—
	—	—	—	—	NK15/20	15		23	20	0.3	21	15 600	20 200	23 000	28	—	—
16	RNA 4901	—	—	—	—	16	+0.027 +0.016	24	13	0.3	22	9 700	11 100	23 000	18.1	IR121613	NA4901
	—	—	—	—	NK16/16	16		24	16	0.3	22	12 300	15 100	23 000	23	IR121616	NKI 12/16
	—	—	—	—	NK16/20	16		24	20	0.3	22	15 600	20 400	23 000	29	IR121620	NKI 12/20
	—	—	RNA 6901	—	—	16		24	22	0.3	22	17 100	23 000	23 000	30	IR121622	NA6901
17	—	—	—	—	NK17/16	17	+0.027 +0.016	25	16	0.3	23	12 800	16 300	22 000	24.5	—	—
	—	—	—	—	NK17/20	17		25	20	0.3	23	16 300	22 100	22 000	30.5	—	—
18	—	—	—	—	NK18/16	18	+0.027 +0.016	26	16	0.3	24	13 400	17 500	21 000	25.5	—	—
	—	—	—	—	NK18/20	18		26	20	0.3	24	17 000	23 600	21 000	32	—	—
19	—	—	—	—	NK19/16	19	+0.033 +0.020	27	16	0.3	25	14 000	18 700	21 000	27	IR151916	NKI 15/16
	—	—	—	—	NK19/20	19		27	20	0.3	25	17 700	25 300	21 000	34	IR151920	NKI 15/20
20	RNA 4902	—	—	—	—	20	+0.033 +0.020	28	13	0.3	26	10 900	13 800	20 000	21.5	IR152013	NA4902
	—	—	—	—	NK20/16	20		28	16	0.3	26	13 900	18 700	20 000	27.5	—	—
	—	RNA 5902	—	—	—	20		28	18	0.3	26	15 700	22 100	20 000	33	IR152018	NA5902
	—	—	—	—	NK20/20	20		28	20	0.3	26	17 600	25 400	20 000	35.5	—	—
	—	—	RNA 6902	—	—	20		28	23	0.3	26	19 300	28 700	20 000	37	IR152023	NA6902

\* 适合油润滑。如果是润滑脂润滑，降低到该数值的 60%。

# 车制型滚针轴承

无内圈

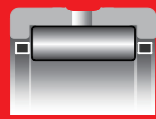

RNA49, RNA59, RNA69 (Fw ≤ 35), NK

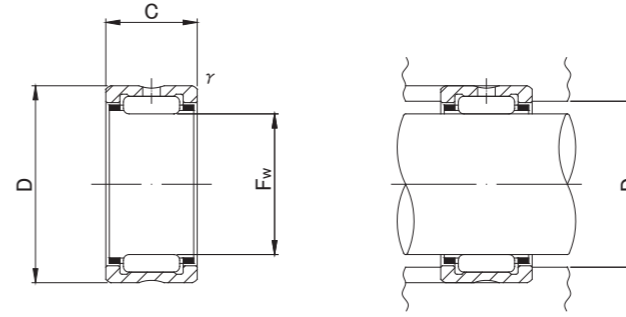

## RNA49, RNA59, RNA69, RNA48, NK 类型

轴直径 (mm)	类型代号					尺寸 (mm)				标准安装尺寸 (mm)	基本额定 动负荷	基本额定 静负荷	允许转速 *	质量	相关轴承型号	
	RNA 49	RNA 59	RNA 69	RNA 48	NK	Fw	D	C	r <sub>s</sub> 最小	Da 最大	Cr N	Cor N	rpm	g (大约)	内圈	带内圈
21	—	—	—	—	NK21/16	21 +0.033	29	16	0.3	27	14 400	20 000	19 000	29	IR172116	NKI 17/16
	—	—	—	—	NK21/20	21 +0.020	29	20	0.3	27	18 200	27 100	19 000	36	IR172120	NKI 17/20
22	RNA 4903	—	—	—	—	22	30	13	0.3	28	11 800	15 600	18 000	23.5	IR172213	NA4903
	—	—	—	—	NK22/16	22	30	16	0.3	28	14 900	21 200	18 000	30	—	—
	—	RNA 5903	—	—	—	22 +0.033	30	18	0.3	28	16 900	24 900	18 000	35	IR172218	NA5903
	—	—	—	—	NK22/20	22 +0.020	30	20	0.3	28	18 900	28 700	18 000	37.5	—	—
	—	—	RNA 6903	—	—	22	30	23	0.3	28	20 800	32 500	18 000	40.5	IR172223	NA6903
24	—	—	—	—	NK24/16	24 +0.033	32	16	0.3	30	15 300	22 600	17 000	32	IR202416	NKI 20/16
	—	—	—	—	NK24/20	24 +0.020	32	20	0.3	30	19 400	30 500	17 000	40.5	IR202420	NKI 20/20
25	—	—	—	—	NK25/16	25	33	16	0.3	31	15 800	23 700	16 000	33.5	—	—
	—	—	—	—	NK25/20	25	33	20	0.3	31	20 000	32 200	16 000	42	—	—
	RNA 4904	—	—	—	—	25 +0.033	37	17	0.3	35	21 000	25 000	16 000	55.5	IR202517	NA4904
	—	RNA 5904	—	—	—	25 +0.020	37	23	0.3	35	29 400	38 600	16 000	84	IR202523	NA5904
	—	—	RNA 6904	—	—	25	37	30	0.3	35	35 400	48 800	16 000	95.5	IR202530	NA6904
26	—	—	—	—	NK26/16	26 +0.033	34	16	0.3	32	16 300	24 900	15 000	34.5	IR222616	NKI 22/16
	—	—	—	—	NK26/20	26 +0.020	34	20	0.3	32	20 600	33 700	15 000	43.5	IR222620	NKI 22/20
	—	—	—	—	—	28	37	20	0.3	35	21 700	37 100	14 000	51.5	—	—
	RNA 49/22	—	—	—	NK28/30	28	37	30	0.3	35	31 100	58 900	14 000	83.5	—	—
	—	RNA 59/22	—	—	—	28 +0.033	39	17	0.3	37	21 400	28 800	14 000	56.5	IR222817	NA49/22
28	—	—	—	—	—	28 +0.020	39	23	0.3	37	29 800	44 400	14 000	92	IR222823	NA59/22
	—	—	RNA 69/22	—	—	28	39	30	0.3	37	36 300	56 900	14 000	97.5	IR222830	NA69/22
	—	—	—	—	—	29	38	20	0.3	36	21 600	37 200	14 000	57	IR252920	NKI 25/20
29	—	—	—	—	NK29/20	29 +0.033	38	20	0.3	36	21 600	37 200	14 000	57	IR252920	NKI 25/20
	—	—	—	—	NK29/30	29 +0.020	38	30	0.3	36	30 900	59 000	14 000	85	IR252930	NKI 25/30

\* 适合油润滑。如果是润滑脂润滑，降低到该数值的 60%。

# 车制型滚针轴承

无内圈

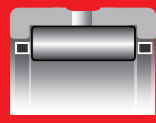

RNA49, RNA59, RNA69 (F<sub>w</sub> ≤ 35), NK

RNA69

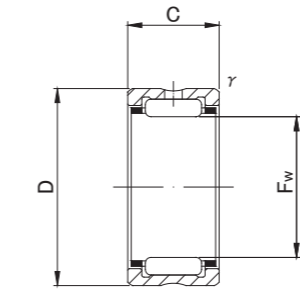

RNA49, RNA59, RNA69 (F<sub>w</sub> ≤ 35), NK

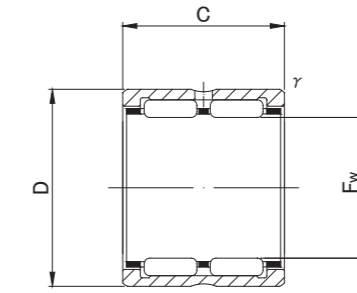

RNA69

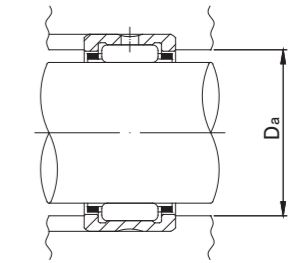

## RNA49, RNA59, RNA69, RNA48, NK 类型

轴直径 (mm)	类型代号					尺寸 (mm)				标准安装尺寸 (mm)	基本额定 动负荷	基本额定 静负荷	允许转速 *	质量	相关轴承型号	
	RNA 49	RNA 59	RNA 69	RNA 48	NK	F <sub>w</sub>	D	C	r <sub>s</sub> 最小						D <sub>a</sub> 最大	Cr N
30	—	—	—	—	NK30/20	30	40	20	0.3	38	25 100	40 100	13 000	64.5	—	—
	—	—	—	—	NK30/30	30	40	30	0.3	38	36 000	63 800	13 000	97.5	—	—
	RNA 4905	—	—	—	—	30	42	17	0.3	40	23 700	30 700	13 000	64	IR253017	NA4905
	—	RNA 5905	—	—	—	30	42	23	0.3	40	33 200	47 500	13 000	101	IR253023	NA5905
	—	—	RNA 6905	—	—	30	42	30	0.3	40	42 100	64 200	13 000	111	IR253030	NA6905
32	—	—	—	—	NK32/20	32	42	20	0.3	40	25 700	42 200	13 000	68	IR283220	NKI 28/20
	—	—	—	—	NK32/30	32	42	30	0.3	40	36 900	67 100	13 000	102	IR283230	NKI 28/30
	RNA 49/28	—	—	—	—	32	45	17	0.3	43	24 500	32 700	13 000	76.5	IR283217	NA49/28
	—	RNA 59/28	—	—	—	32	45	23	0.3	43	34 300	50 500	13 000	108	IR283223	NA59/28
	—	—	RNA 69/28	—	—	32	45	30	0.3	43	41 800	64 700	13 000	133	IR283230	NA69/28
35	—	—	—	—	NK35/20	35	45	20	0.3	43	27 000	46 200	11 000	73.5	IR303520	NKI 30/20
	—	—	—	—	NK35/30	35	45	30	0.3	43	38 600	73 500	11 000	112	IR303530	NKI 30/30
	RNA 4906	—	—	—	—	35	47	17	0.3	45	25 200	34 700	11 000	72.5	IR303517	NA4906
	—	RNA 5906	—	—	—	35	47	23	0.3	45	35 200	53 700	11 000	108	IR303523	NA5906
	—	—	RNA 6906	—	—	35	47	30	0.3	45	43 100	69 000	11 000	125	IR303530	NA6906
37	—	—	—	—	NK37/20	37	47	20	0.3	45	28 200	50 100	11 000	77.5	IR323720	NKI 32/20
	—	—	—	—	NK37/30	37	47	30	0.3	45	40 500	79 800	11 000	117	IR323730	NKI 32/30
38	—	—	—	—	NK38/20	38	48	20	0.3	46	28 100	50 200	11 000	79	—	—
	—	—	—	—	NK38/30	38	48	30	0.3	46	40 300	80 000	11 000	119	—	—
40	—	—	—	—	NK40/20	40	50	20	0.3	48	29 400	54 100	10 000	83	IR354020	NKI 35/20
	—	—	—	—	NK40/30	40	50	30	0.3	48	42 300	86 100	10 000	125	IR354030	NKI 35/30
	RNA 49/32	—	—	—	—	40	52	20	0.6	48	31 300	47 900	10 000	96	IR324020	NA49/32
	—	RNA 59/32	—	—	—	40	52	27	0.6	48	41 900	69 900	10 000	149	IR324027	NA59/32
	—	—	RNA 69/32	—	—	40	52	36	0.6	48	53 500	95 700	10 000	172	IR324036	NA69/32
42	—	—	—	—	NK42/20	42	52	20	0.3	50	29 900	56 200	9 500	86.5	—	—
	—	—	—	—	NK42/30	42	52	30	0.3	50	43 000	89 500	9 500	130	—	—
	RNA 4907	—	—	—	—	42	55	20	0.6	51	32 000	50 200	9 500	113	IR354220	NA4907
	—	RNA 5907	—	—	—	42	55	27	0.6	51	42 900	73 200	9 500	176	IR354227	NA5907
	—	—	RNA 6907	—	—	42	55	36	0.6	51	54 800	100 000	9 500	200	IR354236	NA6907

\* 适合油润滑。如果是润滑脂润滑，降低到该数值的 60%。

# 车制型滚针轴承

无内圈

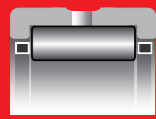

RNA49, RNA59, RNA48, NK



RNA69

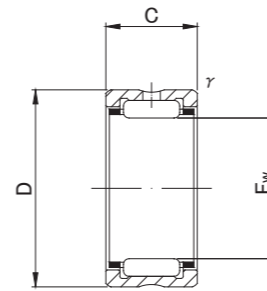

RNA49, RNA59, RNA48, NK

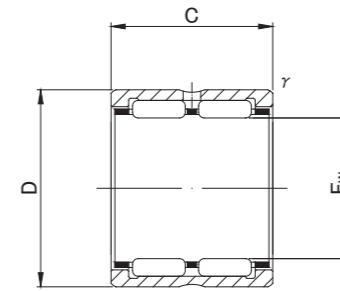

RNA69

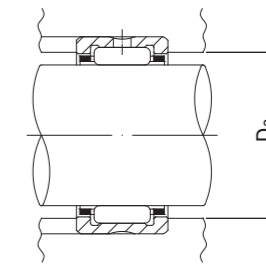

## RNA49, RNA59, RNA69, RNA48, NK 类型

轴直径 (mm)	类型代号					尺寸 (mm)				标准安装尺寸 (mm)	基本额定 动负荷	基本额定 静负荷	允许转速 *	质量	相关轴承型号	
	RNA 49	RNA 59	RNA 69	RNA 48	NK	Fw	D	C	r <sub>s</sub> 最小	Da 最大	Cr N	Cor N	rpm	g (大约)	内圈	带内圈
43	—	—	—	—	NK43/20 NK43/30	43 +0.041	53	20	0.3	51	30 500	58 100	9 500	88.5 133	IR384320 IR384330	NKI 38/20 NKI 38/30
	—	—	—	—		43 +0.025	53	30	0.3	51	43 700	92 500	9 500			
45	—	—	—	—	NK45/20 NK45/30	45 +0.041	55	20	0.3	53	31 100	60 100	9 000	92 138	IR404520 IR404530	NKI 40/20 NKI 40/30
	—	—	—	—		45 +0.025	55	30	0.3	53	44 500	95 700	9 000			
47	—	—	—	—	NK47/20 NK47/30	47 +0.041	57	20	0.3	55	31 500	62 300	8 500	95 144	IR424720 IR424730	NKI 42/20 NKI 42/30
	—	—	—	—		47 +0.025	57	30	0.3	55	45 200	99 000	8 500			
48	RNA 4908	—	—	—	—	48 +0.041	62	22	0.6	58	41 600	67 400	8 500	152 225 275	IR404822 IR404830 IR404840	NA4908 NA5908 NA6908
	—	RNA 5908	—	—	—	48 +0.025	62	30	0.6	58	58 000	103 000	8 500			
	—	—	RNA 6908	—	—	48	62	40	0.6	58	71 300	134 400	8 500			
50	—	—	—	—	NK50/25 NK50/35	50 +0.041	62	25	0.6	58	43 000	85 200	8 000	159 225	IR455025 IR455035	NKI 45/25 NKI 45/35
	—	—	—	—		50 +0.025	62	35	0.6	58	58 100	125 500	8 000			
52	RNA 4909	—	—	—	—	52 +0.049	68	22	0.6	64	43 500	73 400	7 500	197 232 355	IR455222 IR455230 IR455240	NA4909 NA5909 NA6909
	—	RNA 5909	—	—	—	52 +0.030	68	30	0.6	64	60 700	112 000	7 500			
	—	—	RNA 6909	—	—	52	68	40	0.6	64	74 600	147 100	7 500			
55	—	—	—	—	NK55/25 NK55/35	55 +0.049	68	25	0.6	64	45 400	94 100	7 500	193 255	IR505525 IR505535	NKI 50/25 NKI 50/35
	—	—	—	—		55 +0.030	68	35	0.6	64	61 300	138 300	7 500			

\* 适合油润滑。如果是润滑脂润滑，降低到该数值的 60%。

# 车制型滚针轴承

无内圈

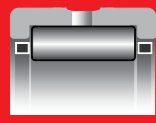

RNA49, RNA59, RNA48, NK



RNA69

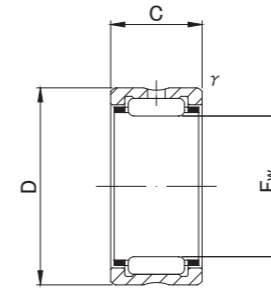

RNA49, RNA59, RNA48, NK

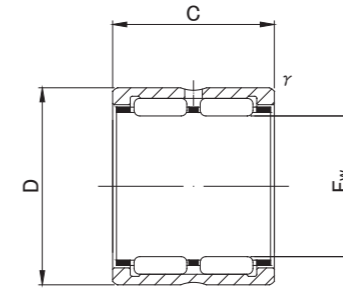

RNA69

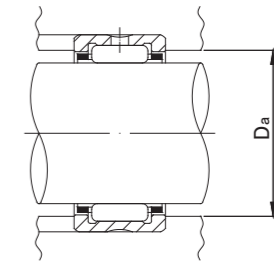

## RNA49, RNA59, RNA69, RNA48, NK 类型

轴直径 (mm)	类型代号					尺寸 (mm)				标准安装尺寸 (mm)	基本额定 动负荷	基本额定 静负荷	允许转速 *	质量	相关轴承型号	
	RNA 49	RNA 59	RNA 69	RNA 48	NK	Fw	D	C	r <sub>s</sub> 最小	Da 最大	Cr N	Cor N	rpm	g (大约)	内圈	带内圈
58	RNA 4910	—	—	—	—	58	72	22	0.6	68	46 200	82 100	7 000	179	IR505822	NA4910
	—	RNA 5910	—	—	—	58 <sup>+0.049</sup>	72	30	0.6	68	64 400	126 000	7 000	289	IR505830	NA5910
	—	—	RNA 6910	—	—	58 <sup>+0.030</sup>	72	40	0.6	68	79 100	163 800	7 000	320	IR505840	NA6910
60	—	—	—	—	<b>NK60/25</b>	60 <sup>+0.049</sup>	72	25	0.6	68	47 500	103 000	6 500	187	IR556025	NKI 55/25
	—	—	—	—	<b>NK60/35</b>	60 <sup>+0.030</sup>	72	35	0.6	68	64 100	151 000	6 500	260	IR556035	NKI 55/35
63	RNA 4911	—	—	—	—	63	80	25	1	75	57 600	97 300	6 500	265	IR556325	NA4911
	—	RNA 5911	—	—	—	63 <sup>+0.049</sup>	80	34	1	75	82 600	154 000	6 500	367	IR556334	NA5911
	—	—	RNA 6911	—	—	63 <sup>+0.030</sup>	80	45	1	75	99 000	194 200	6 500	475	IR556345	NA6911
65	—	—	—	—	<b>NK65/25</b>	65 <sup>+0.049</sup>	78	25	0.6	74	49 600	111 800	6 000	225	—	—
	—	—	—	—	<b>NK65/35</b>	65 <sup>+0.030</sup>	78	35	0.6	74	67 000	164 800	6 000	315	—	—
68	—	—	—	—	<b>NK68/25</b>	68	82	25	0.6	78	54 800	116 700	6 000	250	IR606825	NKI 60/25
	—	—	—	—	<b>NK68/35</b>	68	82	35	0.6	78	72 100	165 700	6 000	350	IR606835	NKI 60/35
	RNA 4912	—	—	—	—	68 <sup>+0.049</sup>	85	25	1	80	60 100	104 900	6 000	285	IR606825	NA4912
	—	RNA 5912	—	—	—	68 <sup>+0.030</sup>	85	34	1	80	86 100	167 000	6 000	408	IR606834	NA5912
	—	—	RNA 6912	—	—	68	85	45	1	80	103 000	210 800	6 000	510	IR606845	NA6912
70	—	—	—	—	<b>NK70/25</b>	70 <sup>+0.049</sup>	85	25	0.6	81	55 500	120 600	5 500	280	—	—
	—	—	—	—	<b>NK70/35</b>	70 <sup>+0.030</sup>	85	35	0.6	81	73 000	170 600	5 500	395	—	—
72	RNA 4913	—	—	—	—	72	90	25	1	85	62 800	113 800	5 500	325	IR657225	NA4913
	—	RNA 5913	—	—	—	72 <sup>+0.049</sup>	90	34	1	85	89 900	180 000	5 500	462	IR657234	NA5913
	—	—	RNA 6913	—	—	72 <sup>+0.030</sup>	90	45	1	85	107 900	226 500	5 500	585	IR657245	NA6913

\* 适合油润滑。如果是润滑脂润滑，降低到该数值的 60%。

# 车制型滚针轴承

无内圈

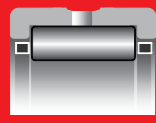

RNA49, RNA59, RNA48, NK



RNA69

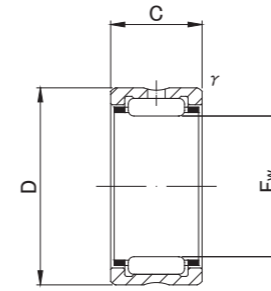

RNA49, RNA59, RNA48, NK

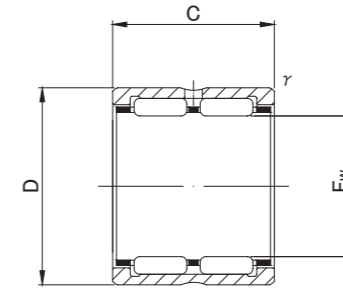

RNA69

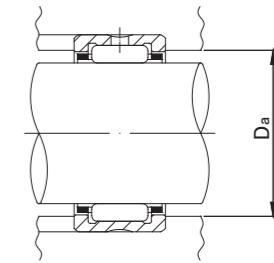

## RNA49, RNA59, RNA69, RNA48, NK 类型

轴直径 (mm)	类型代号					尺寸 (mm)				标准安装尺寸 (mm)	基本额定 动负荷	基本额定 静负荷	允许转速 *	质量	相关轴承型号								
	RNA 49	RNA 59	RNA 69	RNA 48	NK	Fw	D	C	r <sub>s</sub> 最小						Da 最大	Cr N	Cor N	rpm	g (大约)	内圈	带内圈		
73	—	—	—	—	NK73/25 NK73/35	73 +0.049	90	25	0.6	86	61 100	126 500	5 500	335	—	—							
	—	—	—	—		73 +0.030	90	35	0.6								86	80 400	180 400	5 500	475	IR657335	NKI 65/35
75	—	—	—	—	NK75/25 NK75/35	75 +0.049	92	25	0.6	88	62 200	130 400	5 500	345	—	—							
	—	—	—	—		75 +0.030	92	35	0.6								88	82 700	186 300	5 500	485	—	—
80	—	—	—	—	NK80/25 NK80/35	80	95	25	1	90	59 400	137 300	5 000	315	IR708025	NKI 70/25							
	—	—	—	—		80	95	35	1								90	78 100	194 200	5 000	445	IR708035	NKI 70/35
	RNA 4914	—	—	—		80 +0.049	100	30	1								95	83 200	157 900	5 000	495	IR708030	NA4914
	—	RNA 5914	—	—		80 +0.030	100	40	1								95	112 000	232 000	5 000	706	IR708040	NA5914
	—	—	RNA 6914	—		80	100	54	1								95	133 400	310 900	5 000	910	IR708054	NA6914
85	—	—	—	—	NK85/25 NK85/35	85	105	25	1	100	76 400	145 100	4 500	435	IR758525	NKI 75/25							
	RNA 4915	—	—	—		85	105	30	1								100	86 200	169 700	4 500	525	IR758530	NA4915
	—	—	—	—		85 +0.058	105	35	1								100	102 000	209 900	4 500	610	IR758535	NKI 75/35
	—	RNA 5915	—	—		85 +0.036	105	40	1								100	116 000	249 000	4 500	745	IR758540	NA5915
	—	—	RNA 6915	—		85	105	54	1								100	138 300	330 500	4 500	960	IR758554	NA6915
90	—	—	—	—	NK90/25 NK90/35	90	110	25	1	105	77 400	150 000	4 500	456	IR809025	NKI 80/25							
	RNA 4916	—	—	—		90	110	30	1								105	87 400	174 600	4 500	550	IR809030	NA4916
	—	—	—	—		90 +0.058	110	35	1								105	103 000	216 700	4 500	640	IR809035	NKI 80/35
	—	RNA 5916	—	—		90 +0.036	110	40	1								105	117 000	257 000	4 500	787	IR809040	NA5916
	—	—	RNA 6916	—		90	110	54	1								105	143 200	350 100	4 500	1 010	IR809054	NA6916
95	—	—	—	—	NK95/26 NK95/36	95 +0.058	115	26	1	110	79 700	158 900	4 200	495	IR859526	NKI 85/26							
	—	—	—	—		95 +0.036	115	36	1								110	106 900	230 500	4 200	690	IR859536	NKI 85/36
100	—	—	—	—	NK100/26 NK100/36	100	120	26	1	115	82 500	168 700	4 000	525	IR9010026	NKI 90/26							
	RNA 4917	—	—	—		100	120	35	1.1								113.5	109 800	244 200	4 000	705	IR8510035	NA4917
	—	—	—	—		100 +0.058	120	36	1								115	109 800	244 200	4 000	725	IR9010036	NKI 90/36
	—	RNA 5917	—	—		100 +0.036	120	46	1.1								113.5	144 000	346 000	4 000	1 000	IR8510046	NA5917
	—	—	RNA 6917	—		100	120	63	1.1								113.5	172 600	466 800	4 000	1 300	IR8510063	NA6917

\* 适合油润滑。如果是润滑脂润滑，降低到该数值的 60%。

# 车制型滚针轴承

无内圈

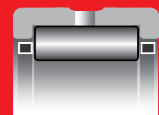

RNA49, RNA59, RNA48, NK



RNA69

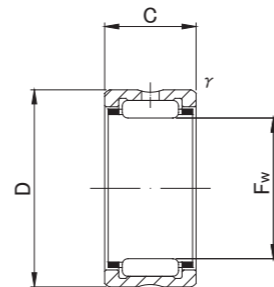

RNA49, RNA59, RNA48, NK

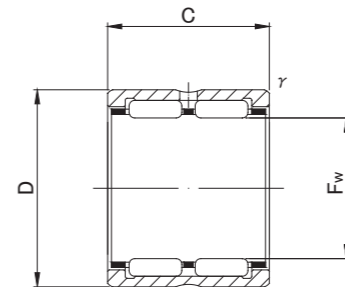

RNA69

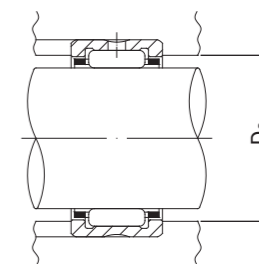

## RNA49, RNA59, RNA69, RNA48, NK 类型

轴直径 (mm)	类型代号					尺寸 (mm)				标准安装尺寸 (mm)	基本额定 动负荷	基本额定 静负荷	允许转速 *	质量	相关轴承型号	
	RNA 49	RNA 59	RNA 69	RNA 48	NK	Fw	D	C	r <sub>s</sub> 最小	Da 最大	Cr N	Cor N	rpm	g (大约)	内圈	带内圈
105	—	—	—	—	<b>NK105/26</b>	105	125	26	1	120	84 700	177 500	3 800	545	IR9510526	NKI 95/26
	<b>RNA 4918</b>	—	—	—	—	105	125	35	1.1	118.5	112 800	257 900	3 800	740	IR9010535	NA4918
	—	—	—	—	<b>NK105/36</b>	105 <sup>+0.058</sup>	125	36	1	120	112 800	257 900	3 800	760	IR9510536	NKI 95/36
	—	<b>RNA 5918</b>	—	—	—	105 <sup>+0.036</sup>	125	46	1.1	118.5	148 000	365 000	3 800	1 040	IR9010546	NA5918
	—	—	<b>RNA 6918</b>	—	—	105	125	63	1.1	118.5	177 500	490 300	3 800	1 360	IR9010563	NA6918
110	—	—	—	—	<b>NK110/30</b>	110	130	30	1.1	123.5	105 900	239 300	3 600	660	IR10011030	NKI 100/30
	<b>RNA 4919</b>	—	—	—	—	110	130	35	1.1	123.5	116 700	270 700	3 600	770	IR9511035	NA4919
	—	—	—	—	<b>NK110/40</b>	110 <sup>+0.058</sup>	130	40	1.1	123.5	133 400	323 600	3 600	880	IR10011040	NKI 100/40
	—	<b>RNA 5919</b>	—	—	—	110 <sup>+0.036</sup>	130	46	1.1	123.5	152 000	384 000	3 600	1 130	IR9511046	NA5919
	—	—	<b>RNA 6919</b>	—	—	110	130	63	1.1	123.5	182 400	514 800	3 600	1 420	IR9511063	NA6919
115	<b>RNA 4920</b>	—	—	—	—	115 <sup>+0.058</sup>	140	40	1.1	133.5	145 000	329 000	3 500	1 190	IR10011540	NA4920
120	—	—	—	<b>RNA 4822</b>	—	120 <sup>+0.058</sup>	140	30	1	135	93 000	239 000	3 500	790	IR11012030	NA4822
125	<b>RNA 4922</b>	—	—	—	—	125 <sup>+0.068</sup>	150	40	1.1	143.5	152 000	357 000	3 000	1 280	IR11012540	NA4922
130	—	—	—	<b>RNA 4824</b>	—	130 <sup>+0.068</sup>	150	30	1	145	97 000	259 000	3 000	850	IR12013030	NA4824
135	<b>RNA 4924</b>	—	—	—	—	135 <sup>+0.068</sup>	165	45	1.1	158.5	187 000	435 000	3 000	1 930	IR12013545	NA4924

\* 适合油润滑。如果是润滑脂润滑，降低到该数值的 60%。



# 车制型滚针轴承

无内圈

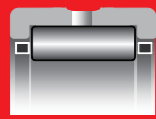

RNA49, RNA59, RNA48, NK



RNA69

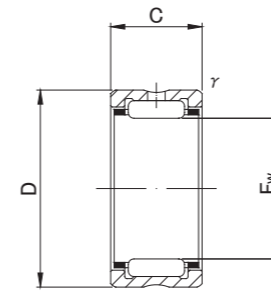

RNA49, RNA59, RNA48, NK

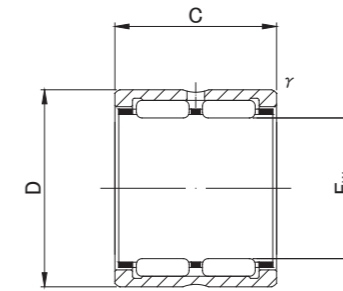

RNA69

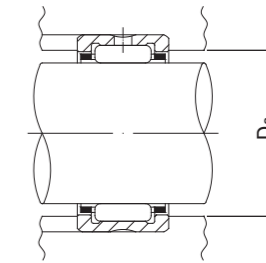

## RNA49, RNA59, RNA69, RNA48, NK 类型

轴直径 (mm)	类型代号					尺寸 (mm)				标准安装尺寸 (mm)	基本额定 动负荷	基本额定 静负荷	允许转速 *	质量	相关轴承型号	
	RNA 49	RNA 59	RNA 69	RNA 48	NK	Fw	D	C	r <sub>s</sub> 最小	Da 最大	Cr N	Cor N	rpm	g (大约)	内圈	带内圈
145	—	—	—	<b>RNA 4826</b>	—	145 <sup>+0.068</sup> / <sub>+0.043</sub>	165	35	1.1	158.5	117 000	340 000	3 000	1 100	IR13014535	NA4826
150	<b>RNA 4926</b>	—	—	—	—	150 <sup>+0.068</sup> / <sub>+0.043</sub>	180	50	1.5	172	216 000	540 000	2 500	2 360	IR13015050	NA4926
155	—	—	—	<b>RNA 4828</b>	—	155 <sup>+0.068</sup> / <sub>+0.043</sub>	175	35	1.1	168.5	121 000	363 000	2 500	1 170	IR14015535	NA4828
160	<b>RNA 4928</b>	—	—	—	—	160 <sup>+0.068</sup> / <sub>+0.043</sub>	190	50	1.5	182	224 000	580 000	2 500	2 500	IR14016050	NA4928
165	—	—	—	<b>RNA 4830</b>	—	165 <sup>+0.068</sup> / <sub>+0.043</sub>	190	40	1.1	183.5	168 000	446 000	2 500	1 750	IR15016540	NA4830
175	—	—	—	<b>RNA 4832</b>	—	175 <sup>+0.068</sup> / <sub>+0.043</sub>	200	40	1.1	193.5	173 000	474 000	2 500	1 850	IR16017540	NA4832

\* 适合油润滑。如果是润滑脂润滑，降低到该数值的60%。